



MWPTT

MICRO WIRELESS PUSH-TO-TALK



WIRELESS PRIMARY / SECONDARY PTT

PICATINNY MOUNTED

PLUG AND PLAY SIMPLICITY

IP67 WATER PROOF

FINGER / PALM PTT (OPTIONAL)

INTERNAL AAA BATTERY

The Silynx Micro Wireless Push-to-Talk (MWPTT) enables users to remotely and wirelessly PTT their comms devices.

Pair the MWPTT with a Silynx control box in seconds, and it will PTT up to two devices, including radios, smartphones, and various ICS platforms. Supports a removable ring finger PTT, ideal for snipers, tactical drivers & airborne operations.



SYSTEM

Wireless PTT without finger PTT jack

MWPTT-006

Wireless PTT with finger PTT jack

MWPTT-004

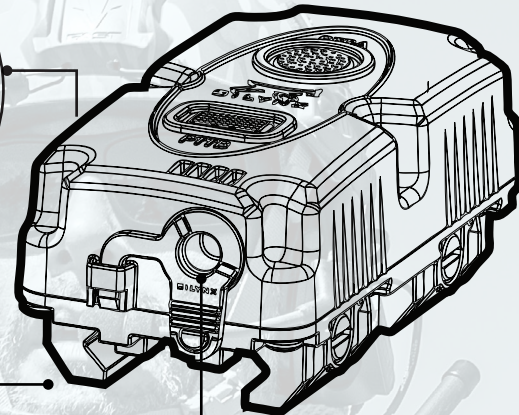
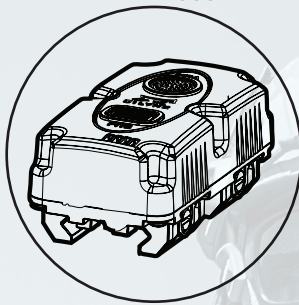
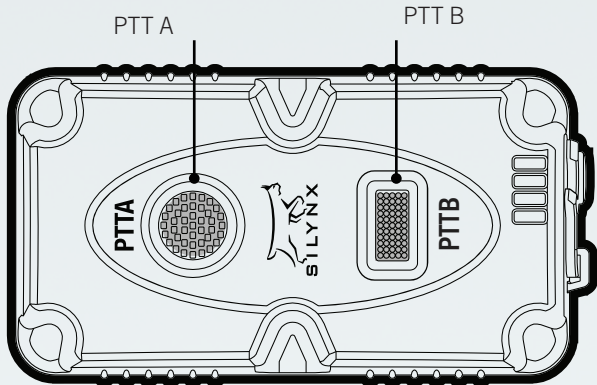

Picatinny Rail Adaptor

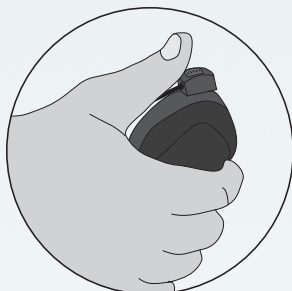

Gear stick PTT Option

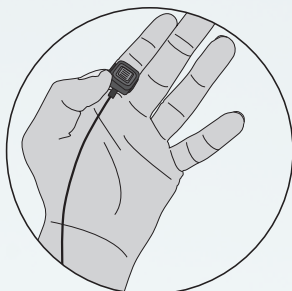

Wired Finger PTT Option

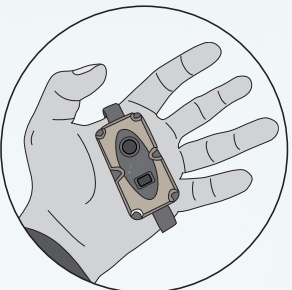

Palm Strap Option



Wired Palm PTT Option

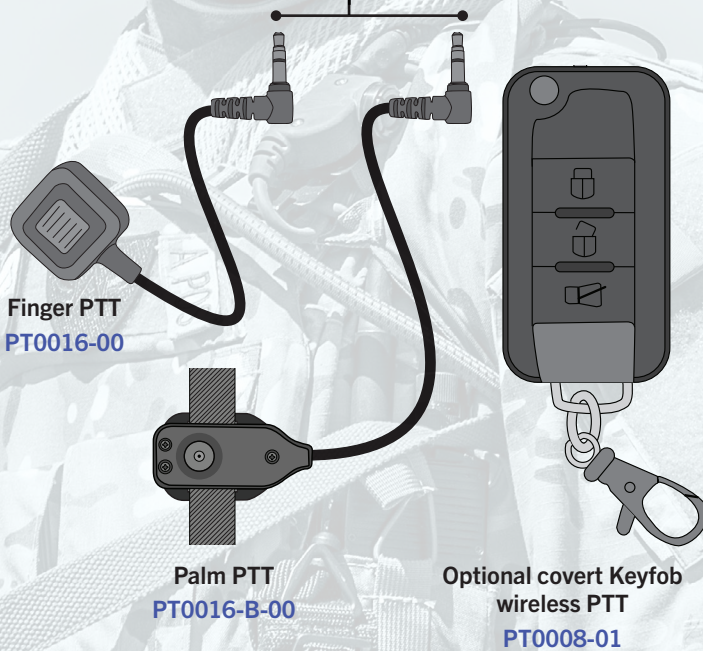

Finger PTT
PT0016-00

Palm PTT
PT0016-B-00

Optional covert Keyfob
wireless PTT
PT0008-01

TECH SPECS

Wireless

RF Transceiver 2.4 GHz IEEE 802.15.4
 Protocol..... ZigBee 2006
 Range..... 2m

Battery life Expectancy

Internal 1.5V AAA Battery.....1 Year

Control System

Picatinny rail mount
 Optional wrist strap
 Optional Ring PTT

*Specifications are subject to change without notice.

Environmental

Operating Temperature..... -31°C to +70°C
 Storage Temperature..... -40°C to +75°C
 Humidity..... 95% at ambient temp range +30 to +60 C
 Altitude..... 40,000 ft
 Immersion..... IP67

Dimensions

MWPTT..... 2.50" L x 1.35" W x 0.80" H

Weight

MWPTT..... 44.38g (including battery)