



PROTECTION FROM WITHIN™

CLARUS DUALIX HEADSET SYSTEM

USER GUIDE

CLARUS SYSTEM COMPONENTS



Clarus
Control Box

*Optional

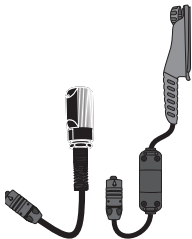

Radio Cable
Adaptors*



User Guide

PROTEGO PRO/STD Headset*



Vest Mounted
Boom Mic*



Bluetooth
Adaptor*



Gas Mask
Adaptor*



Dual Comms
Splitter Cable*



Wireless PTT*

CLARUS CONTROL BOX

3

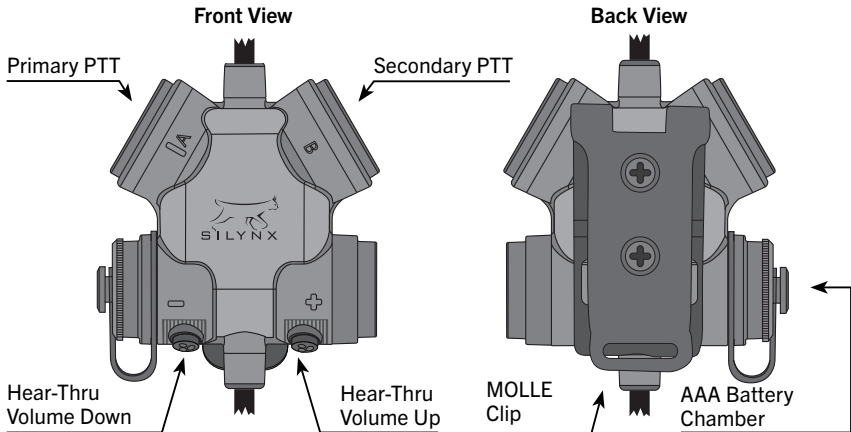

PROTEGO HEADSET

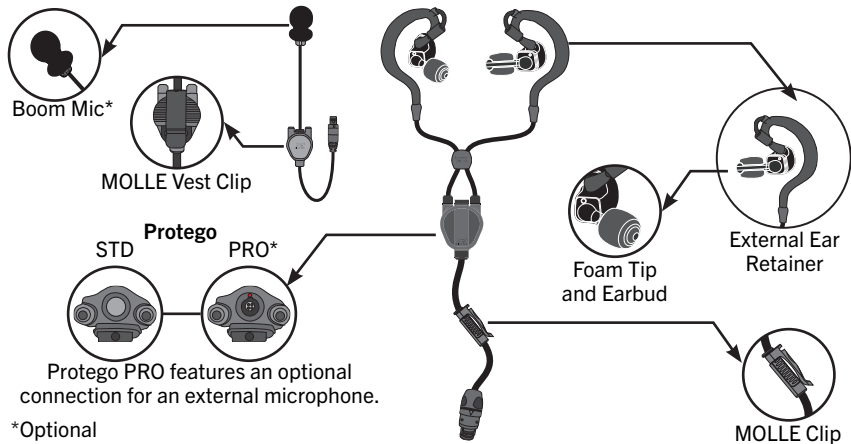

PROTEGO EARBUD COMPONENTS

5

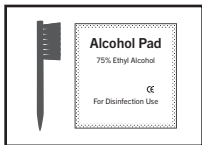
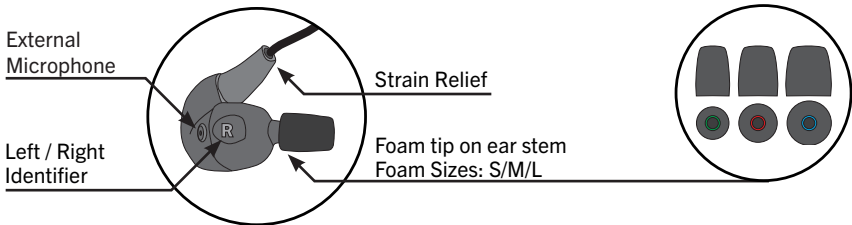

Cleaning Kit (brush and alcohol pad)

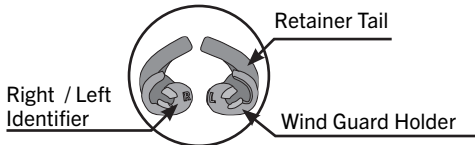

Optional Internal Ear Retainers S/M/L



1. Connect radio adaptor to control box

2. Connect headset to control box

Single Radio Configuration

Radio Cable Adaptor

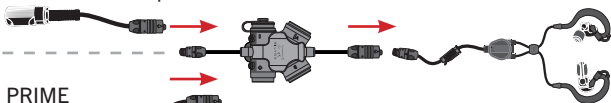

Dual Radio Configuration

Primary Radio Adaptor

PRIME

Secondary Radio Adaptor

SEC

Dual Comms Splitter Cable

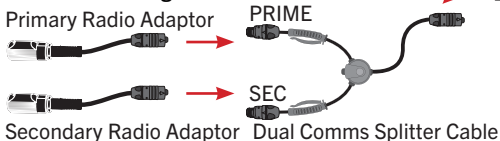

Connect the dual comms splitter cable to the control box. Connect the primary radio cable adaptor to the port labeled as “PRIME” on the splitter, and connect the secondary radio cable adaptor to the “SEC” port.

Note: In dual configuration, PTT A activates the primary radio, while PTT B activates the secondary radio. In single radio mode, both PTT buttons activate the radio.

MOUNTING THE CONTROL BOX

7

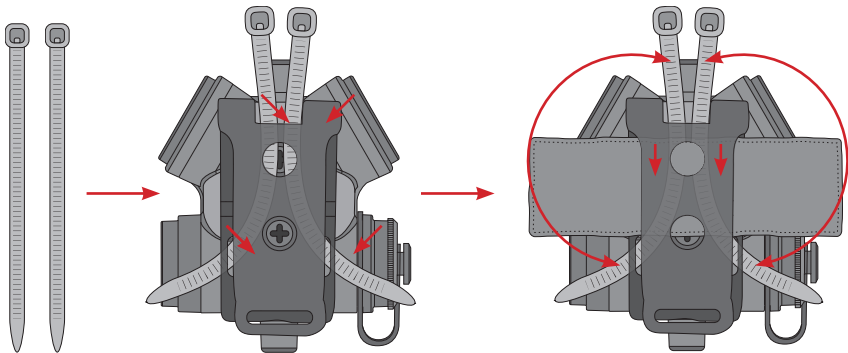

1. Insert two zip ties as shown in the illustration.

2. Insert the clip into the MOLLE attachment and ensure it is secured by tightening the zip ties around it.

INSERTING EARBUDS

1. Select the largest ear tip that fits comfortably in your ear.

***Optional:** Internal Ear Retainer. (see next page).

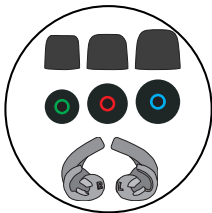

3. Compress the foam tip using a rotational motion until it becomes long and narrow.

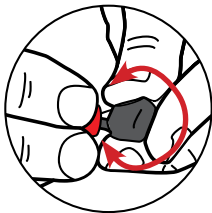

2. Position the foam tip onto the earbud stem by sliding it into place.

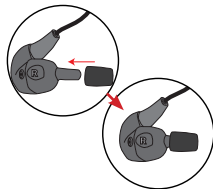

4. Quickly insert the earbud into your ear canal and hold for a few seconds to allow the foam to expand within your ear. Then place the External Ear Retainer over the ear.



INSERTING INTERNAL EAR RETAINER 9

In windy conditions, use the internal ear retainer to reduce wind noise.

1. Select a pair of Internal Ear Retainers that are suitable for your ear size.

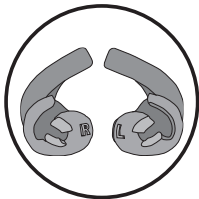

2. Enclose the earbud with the Internal Ear Retainer, ensuring that the ear stem extends outward.

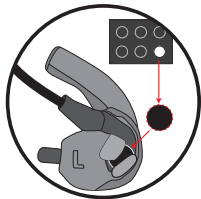

3. Place wind foam inside the retainer's cavity over the external mic.

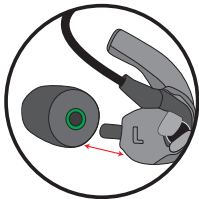

4. Slide the foam tip over the earbud stem. Insert the earbud into your ear canal.



The Protego PRO allows you to connect an external microphone to the system. When you plug an external microphone into the earphone jack, it becomes the primary microphone. If the external microphone is removed, the system will revert to its default microphone configuration, which may be either “In-Ear” Mode or “Whisper Mode,” based on the user’s prior selection.

Available External Microphone Options:



Boom Microphone for
a vest



Gas Mask
Microphone Connection

OPERATION

11

1. Connect the radio cable adaptor to the radio and power it on. The unit is usually powered by the radio. In a dual comms setup, only one radio needs to provide power.

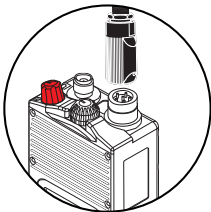

2. If your radio or communication device doesn't provide power to the headset, use an AAA battery.

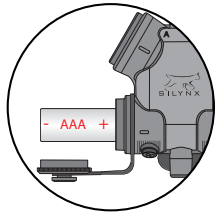

3. To power on the system on, press and hold the "+" key for 5 seconds until you hear the "Unit On" prompt.

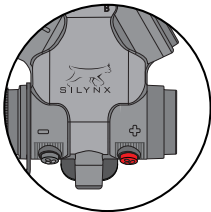

4. To turn the system off, press and hold the "+" key for 5 seconds until you hear the "Unit Off" prompt.

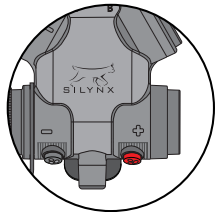

LEAK TEST

When the system is powered on, a leak test is initiated automatically, followed by two beeps (one for each ear). This test indicates that the ear foams are correctly placed for optimal performance and protection.

After the test, if a sound leak is detected, a voice prompt will announce: **“Leak Left”**, **“Leak Right”**, or **“Leak Both”**. If a leak is detected, adjust the earbud or try a larger ear foam for a better seal.

To manually initiate the test, press the [-] and [+] buttons simultaneously for 4 seconds.

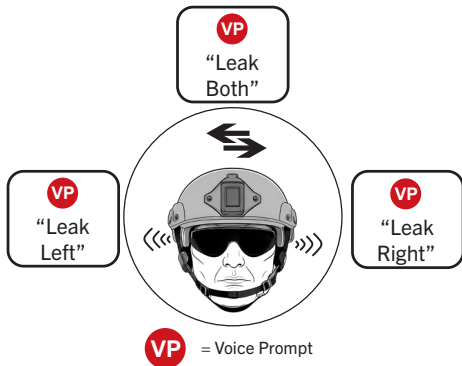

Note: The leak test serves as a preliminary indication and does not ensure the complete sealing of the earbud.

The “Hear-Thru” feature allows users to hear ambient sounds while wearing the headset. It enhances situational awareness by amplifying external sounds, without compromising hearing protection. Users can adjust Hear-Thru sensitivity by modifying the level of external sound depending on the environment, ensuring both awareness and protection in various operational settings.

Press (-) key to decrease
Hear-Thru sensitivity level

Press (+) key to increase
Hear-Thru sensitivity level

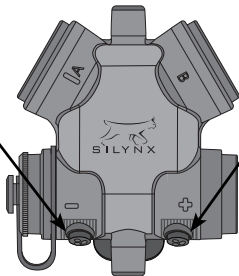
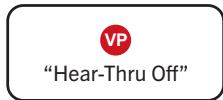

VP = Voice Prompt

Note: In HAHO/HALO and strong wind environments, it is recommended to decrease the Hear-Thru to the lowest level.

The Clarus system offers two speech microphone modes:

1. **In-Ear Mode:** The internal microphone transmits the user's voice directly from the ear canal.
2. **Whisper Mode:** The external earbud microphone captures the user's voice.

In quiet environments, users can activate Whisper Mode for better sensitivity to low-volume speech. In noisy environments, it is recommended to use In-Ear Mode exclusively.

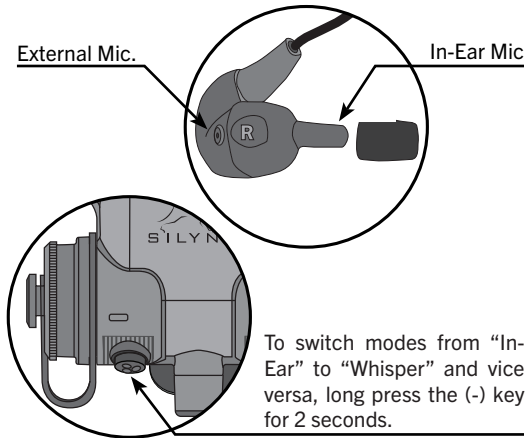

To switch modes from "In-Ear" to "Whisper" and vice versa, long press the (-) key for 2 seconds.

Net monitoring relies on signals received from either the primary or secondary radio, or both (when using the optional dual comms adaptor). The system differentiates the signals sent to each ear based on the radio connection(s).

One Radio Connected

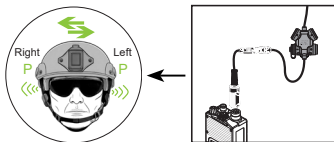

When one radio is connected, the primary signal will be heard in both ears. Both Clarus PTT buttons will operate the radio.

Two Radios Connected

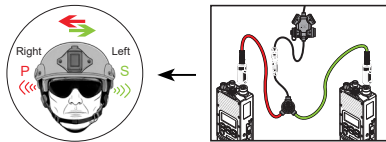

When both radios are connected, the primary signal is transmitted to the right ear, and the secondary in the left. Each network is assigned a different PTT button on the Clarus.

Connected directly to the Clarus:

1. Hold PTT A to transmit your voice to the phone. Your voice will only be heard when you press and hold PTT A.
2. Short press PTT B to answer / end calls. On some phones, pressing and holding PTT B can mute your phone until you press and hold it again.

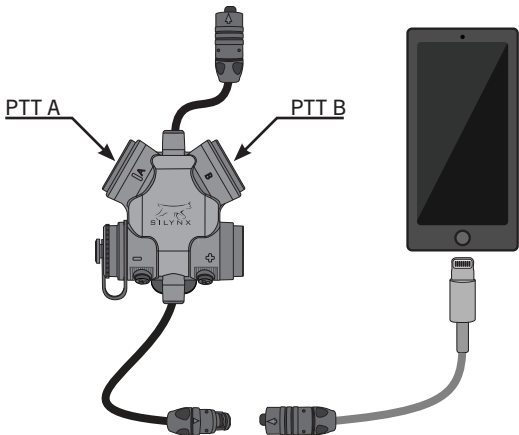

Connected to dual comms splitter:

1. When connected to Primary line hold PTT A to transmit. Short press PTT A to answer / end calls.
2. When connected to Secondary line hold PTT B to transmit. Short press PTT B to answer / end calls.

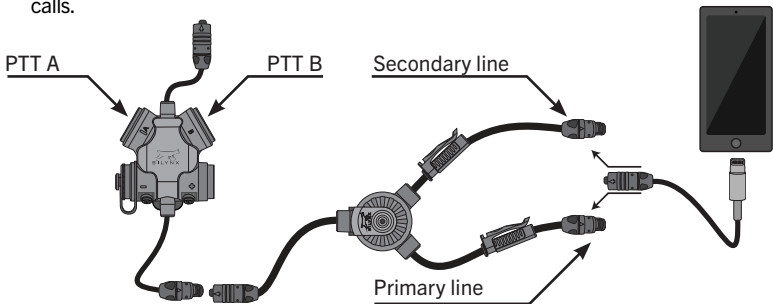

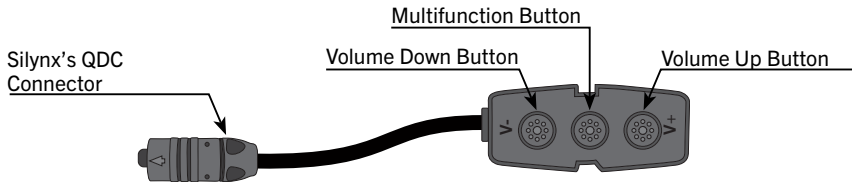

*The Bluetooth Dongle is an **optional** Clarus cable adaptor. It can enable encrypted Bluetooth connections to a mobile phone. Use a Clarus AAA battery if no radio power is available.

Refer to the Bluetooth Guide for detailed instructions.

1. Power on Clarus.
2. Press either PTT buttons on Clarus 5 times, rapidly within the first minute of powering on.
3. After the fifth press, wait until you hear a slow, repetitive beeping tone in the headset. This indicates that the Clarus is in pairing mode.
4. Position the MWPTT within 2 feet of the Clarus.
5. Press both PTT buttons on the MWPTT unit simultaneously.
6. A series of three rapid beeps will signify that the pairing has been successfully completed.

Note: Pairing must occur within 60 seconds after powering on the Clarus.

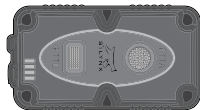
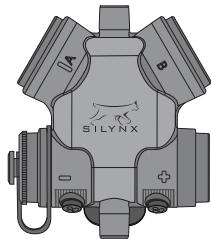

*The Micro Wireless Push To Talk (MWPTT) is an optional accessory.

Proper cleaning and maintenance of your Clarus headset are essential to ensure optimal performance and longevity. Accumulated earwax is a common cause of hearing malfunctions, so regular cleaning is strongly recommended.

Cleaning Instructions

1. Carefully remove the foam earbud by gently detaching it from the ear stem.
2. Utilize the soft brush provided in your kit to gently remove earwax or debris on the end of the ear stem or the external mic on the earbud.
3. **Utilizing the Alcohol Pad:**
Wipe the ear stem and the external microphone with the provided alcohol pad to thoroughly remove any remaining earwax or debris.
4. **Avoid Sharp Objects:**
It is advised against using sharp or pointed objects to clean the ear stem holes. Such actions may damage the internal speaker and microphone, which could result in operational issues.
5. **Replacing Foam Earplug:**
Foam tip ear plugs must be replaced if there are any signs of rips or tears, irrespective of the circumstances, or at least every two months to maintain

optimal hygiene and functionality. The lifespan of ear plugs can be influenced by various factors, including ear wax, oils, chemicals, usage patterns, and environmental conditions

Preventative Maintenance Care

Cleaning your earbuds regularly, particularly following prolonged usage or in environments where earwax buildup is likely. Adequate maintenance will ensure optimal audio clarity and prolong the lifespan of your headset.

By following these steps, you can ensure the continued performance, reliability, and cleanness of your Clarus headset.

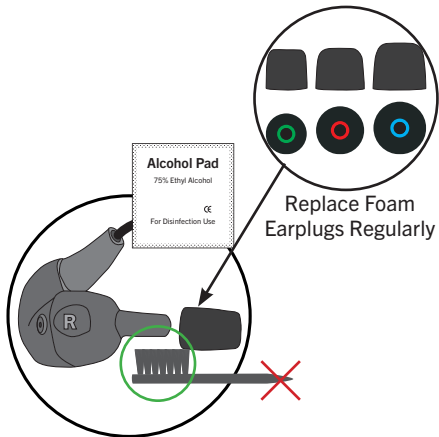



PROTECTION IS POWER

PROPRIETARY NOTICE: This document contains information that is proprietary to Silynx Communications, Inc. It is provided exclusively for operational and support needs and is not intended for procurement activities. Silynx Communications, Inc. retains all rights related to procurement and manufacturing. Any use of this document, either directly or indirectly, requires prior written consent from an authorized representative of Silynx Communications, Inc.

www.silynxcom.com

1.866.325.1731 | info@silynxcom.com | customersupport@silynxcom.com

CLARUS DUAL IX User Guide -DOC-USM000057 - January 2025

ALL RIGHTS RESERVED COPYRIGHT ©